

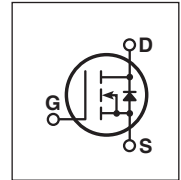

Super Junction FREDFET

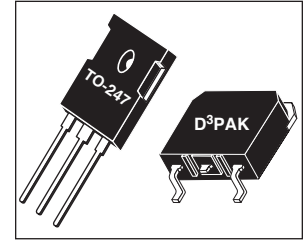

- Ultra Low $R_{DS(ON)}$
- Low Miller Capacitance
- Ultra Low Gate Charge, Q_g
- Avalanche Energy Rated
- Extreme dv/dt Rated
- Intrinsic Fast-Recovery Body Diode
- Extreme Low Reverse Recovery Charge
- Ideal For ZVS Applications
- Popular TO-247 or Surface Mount D³ Package

MAXIMUM RATINGS

 All Ratings: $T_C = 25^\circ\text{C}$ unless otherwise specified.

Symbol	Parameter	APT20N60BCF(G)_SCF(G)	UNIT
V_{DSS}	Drain-Source Voltage	600	Volts
I_D	Continuous Drain Current @ $T_C = 25^\circ\text{C}$	20	Amps
	Continuous Drain Current @ $T_C = 100^\circ\text{C}$	13	
I_{DM}	Pulsed Drain Current ^①	60	
V_{GS}	Gate-Source Voltage Continuous	± 30	Volts
P_D	Total Power Dissipation @ $T_C = 25^\circ\text{C}$	208	Watts
	Linear Derating Factor	1.67	W/ $^\circ\text{C}$
T_J, T_{STG}	Operating and Storage Junction Temperature Range	-55 to 150	$^\circ\text{C}$
T_L	Lead Temperature: 0.063" from Case for 10 Sec.	260	
dv/dt	Drain-Source Voltage slope ($V_{DS} = 480\text{V}$, $I_D = 20\text{A}$, $T_J = 125^\circ\text{C}$)	80	V/ns
I_{AR}	Avalanche Current ^⑦	20	Amps
E_{AR}	Repetitive Avalanche Energy ^⑦	1	mJ
E_{AS}	Single Pulse Avalanche Energy ^④	690	

STATIC ELECTRICAL CHARACTERISTICS

Symbol	Characteristic / Test Conditions	MIN	TYP	MAX	UNIT
BV_{DSS}	Drain-Source Breakdown Voltage ($V_{GS} = 0\text{V}$, $I_D = 250\mu\text{A}$)	600			Volts
$R_{DS(on)}$	Drain-Source On-State Resistance ^② ($V_{GS} = 10\text{V}$, $I_D = 13\text{A}$)			0.220	Ohms
I_{DSS}	Zero Gate Voltage Drain Current ($V_{DS} = 600\text{V}$, $V_{GS} = 0\text{V}$)			2.1	μA
	Zero Gate Voltage Drain Current ($V_{DS} = 600\text{V}$, $V_{GS} = 0\text{V}$, $T_C = 150^\circ\text{C}$)			1700	
I_{GSS}	Gate-Source Leakage Current ($V_{GS} = \pm 20\text{V}$, $V_{DS} = 0\text{V}$)			± 100	nA
$V_{GS(th)}$	Gate Threshold Voltage ($V_{DS} = V_{GS}$, $I_D = 1\text{mA}$)	3	4	5	Volts

 CAUTION: These Devices are Sensitive to Electrostatic Discharge. Proper Handling Procedures Should Be Followed.

 APT Website - <http://www.advancedpower.com>

"COOLMOS™ comprise a new family of transistors developed by Infineon Technologies AG. "COOLMOS" is a trademark of Infineon Technologies AG."

DYNAMIC CHARACTERISTICS

APT20N60BCF(G)_SCF(G)

Symbol	Characteristic	Test Conditions	MIN	TYP	MAX	UNIT
C_{iss}	Input Capacitance	$V_{GS} = 0V$ $V_{DS} = 25V$ $f = 1\text{ MHz}$		2520		pF
C_{oss}	Output Capacitance			670		
C_{rss}	Reverse Transfer Capacitance			40		
Q_g	Total Gate Charge ^③	$V_{GS} = 10V$ $V_{DD} = 300V$ $I_D = 20A @ 25^\circ C$		95		nC
Q_{gs}	Gate-Source Charge			18		
Q_{gd}	Gate-Drain ("Miller") Charge			55		
$t_{d(on)}$	Turn-on Delay Time	RESISTIVE SWITCHING $V_{GS} = 15V$ $V_{DD} = 380V$ $I_D = 20A @ 25^\circ C$ $R_G = 3.6\Omega$		12		ns
t_r	Rise Time			15		
$t_{d(off)}$	Turn-off Delay Time			60		
t_f	Fall Time			6.4		
E_{on}	Turn-on Switching Energy ^⑥	INDUCTIVE SWITCHING @ 25°C $V_{DD} = 400V, V_{GS} = 15V$ $I_D = 20A, R_G = 5\Omega$		180		μJ
E_{off}	Turn-off Switching Energy			60		
E_{on}	Turn-on Switching Energy ^⑥	INDUCTIVE SWITCHING @ 125°C $V_{DD} = 400V, V_{GS} = 15V$ $I_D = 20A, R_G = 5\Omega$		315		
E_{off}	Turn-off Switching Energy			80		

SOURCE-DRAIN DIODE RATINGS AND CHARACTERISTICS

Symbol	Characteristic / Test Conditions	MIN	TYP	MAX	UNIT
I_S	Continuous Source Current (Body Diode)			20	Amps
I_{SM}	Pulsed Source Current ^① (Body Diode)			60	
V_{SD}	Diode Forward Voltage ^② ($V_{GS} = 0V, I_S = -20A$)			1.2	Volts
dv/dt	Peak Diode Recovery dv/dt ^⑤			40	V/ns
t_{rr}	Reverse Recovery Time ($I_S = -20A, di/dt = 100A/\mu s$)	$T_J = 25^\circ C$		180	ns
		$T_J = 125^\circ C$		260	
Q_{rr}	Reverse Recovery Charge ($I_S = -20A, di/dt = 100A/\mu s$)	$T_J = 25^\circ C$		1.4	μC
		$T_J = 125^\circ C$		2.5	
I_{RRM}	Peak Recovery Current ($I_S = -20A, di/dt = 100A/\mu s$)	$T_J = 25^\circ C$		15	Amps
		$T_J = 125^\circ C$		18	

THERMAL CHARACTERISTICS

Symbol	Characteristic	MIN	TYP	MAX	UNIT
$R_{\theta JC}$	Junction to Case			0.60	$^\circ C/W$
$R_{\theta JA}$	Junction to Ambient			62	

- ① Repetitive Rating: Pulse width limited by maximum junction temperature
- ② Pulse Test: Pulse width < 380 μs , Duty Cycle < 2%
- ③ See MIL-STD-750 Method 3471
- ④ Starting $T_J = +25^\circ C$, $L = 13.80mH$, $R_G = 25\Omega$, Peak $I_L = 10A$
- ⑤ dv/dt numbers reflect the limitations of the test circuit rather than the device itself. $I_S \leq -10A$, $di/dt \leq 700A/\mu s$, $V_R \leq 480V$, $T_J \leq 125^\circ C$
- ⑥ E_{on} includes diode reverse recovery. See figures 18, 20.
- ⑦ Repetitive avalanche causes additional power losses that can be calculated as $P_{AV} = E_{AR} \cdot f$

APT Reserves the right to change, without notice, the specifications and information contained herein.

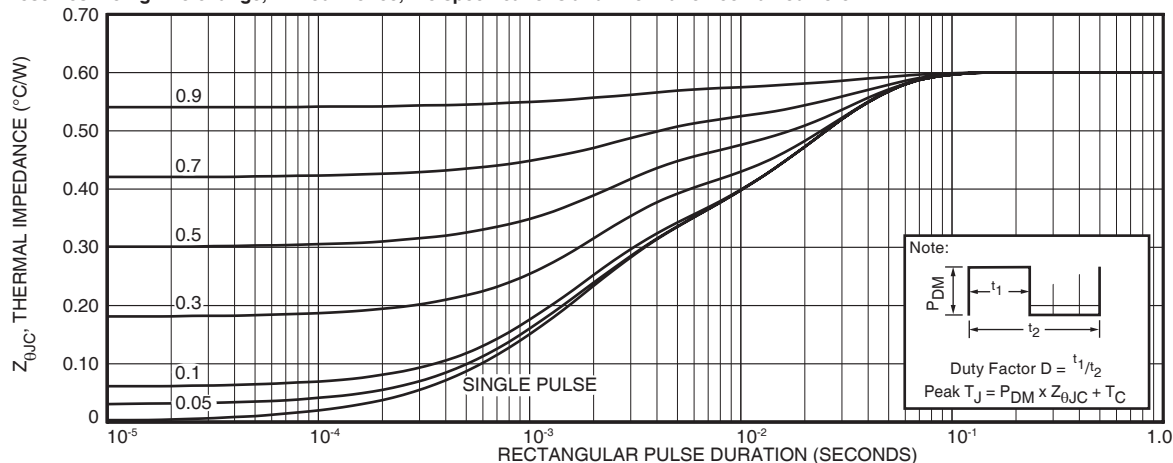

Typical Performance Curves

APT20N60BCF(G)_SCF(G)

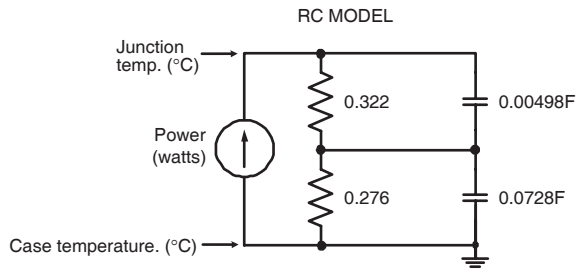

FIGURE 2, TRANSIENT THERMAL IMPEDANCE MODEL

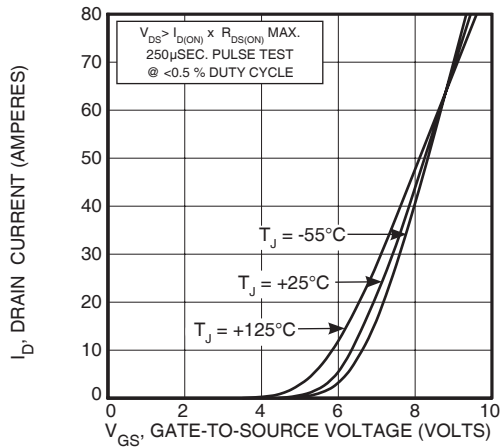

FIGURE 4, TRANSFER CHARACTERISTICS

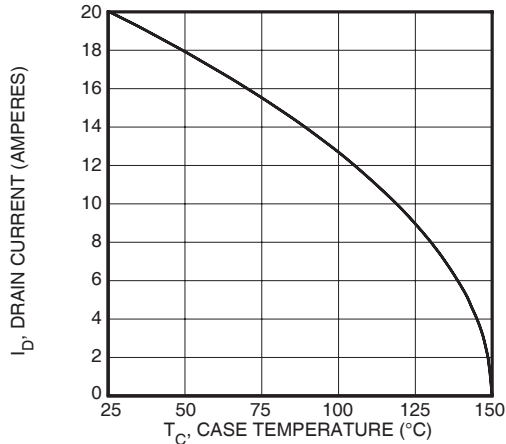

FIGURE 6, MAXIMUM DRAIN CURRENT vs CASE TEMPERATURE

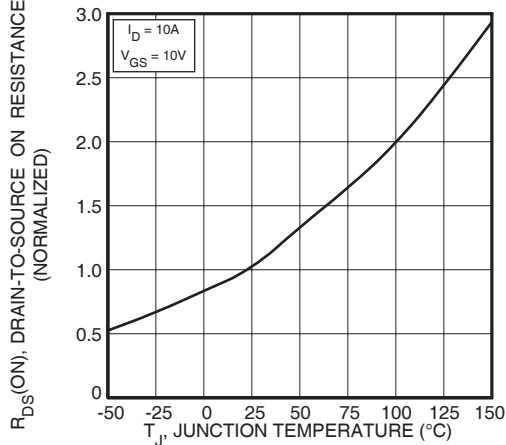

FIGURE 8, ON-RESISTANCE vs. TEMPERATURE

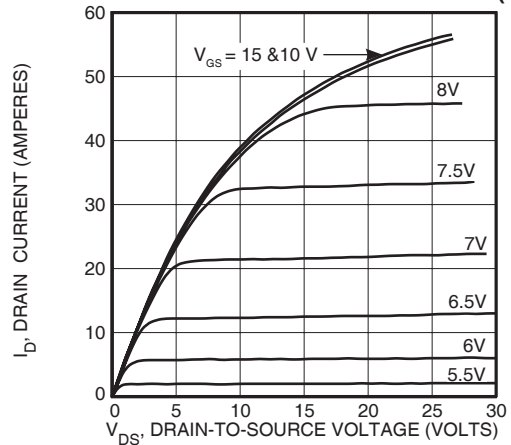

FIGURE 3, LOW VOLTAGE OUTPUT CHARACTERISTICS

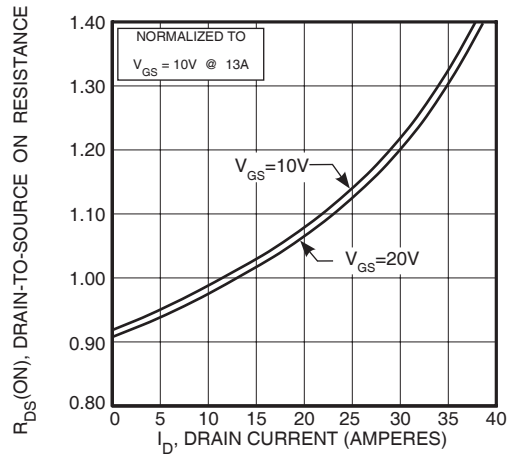

FIGURE 5, $R_{DS(ON)}$ vs DRAIN CURRENT

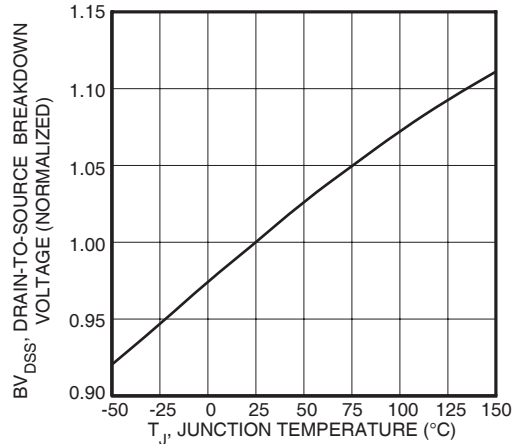

FIGURE 7, BREAKDOWN VOLTAGE vs TEMPERATURE

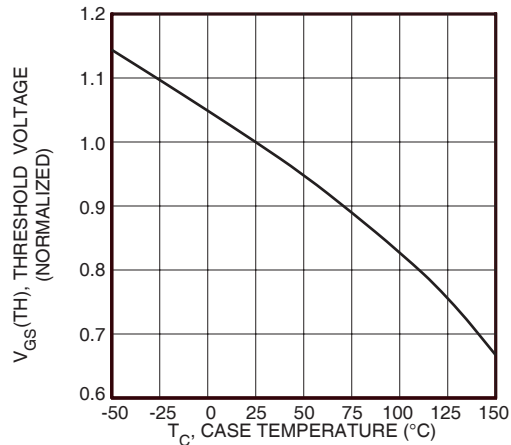

FIGURE 9, THRESHOLD VOLTAGE vs TEMPERATURE

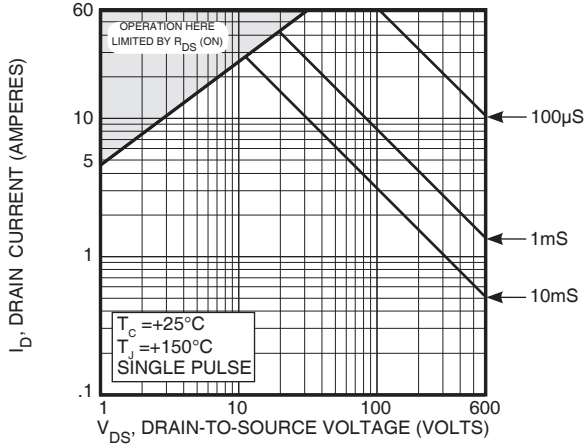

FIGURE 10, MAXIMUM SAFE OPERATING AREA

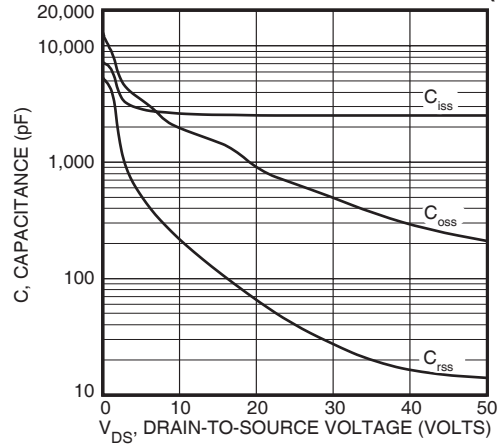

FIGURE 11, CAPACITANCE vs DRAIN-TO-SOURCE VOLTAGE

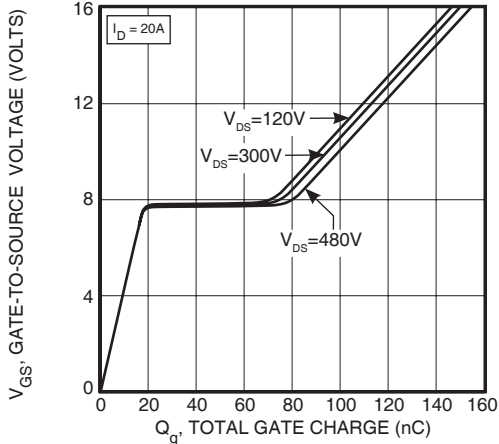

FIGURE 12, GATE CHARGE vs GATE-TO-SOURCE VOLTAGE

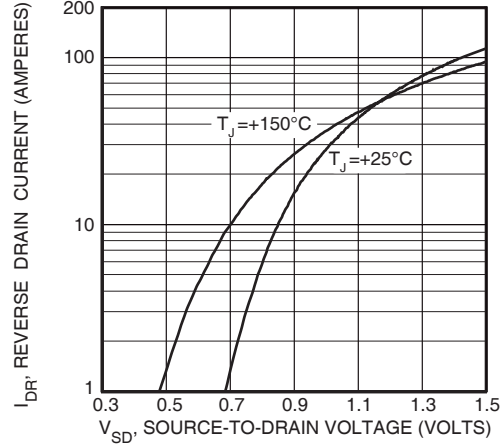

FIGURE 13, SOURCE-DRAIN DIODE FORWARD VOLTAGE

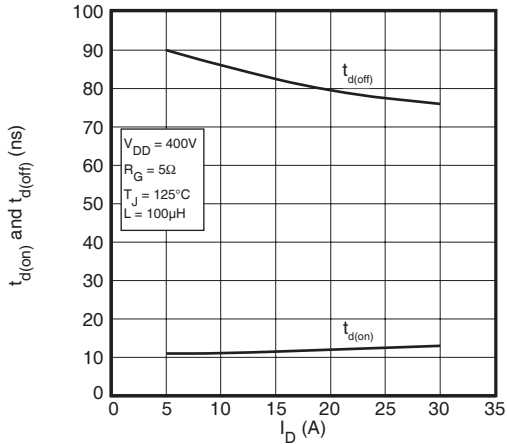

FIGURE 14, DELAY TIMES vs CURRENT

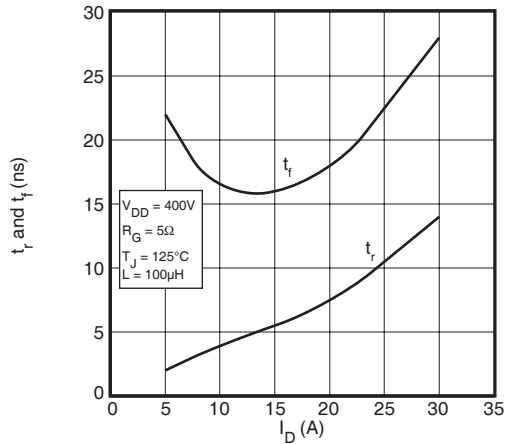

FIGURE 15, RISE AND FALL TIMES vs CURRENT

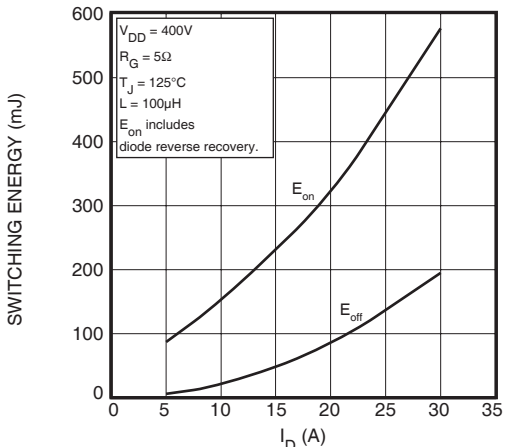

FIGURE 16, SWITCHING ENERGY vs CURRENT

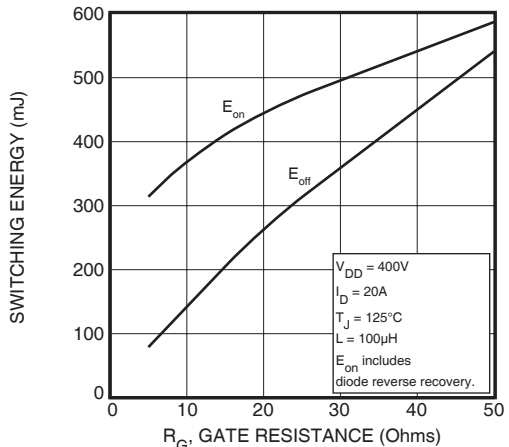

FIGURE 17, SWITCHING ENERGY vs. GATE RESISTANCE

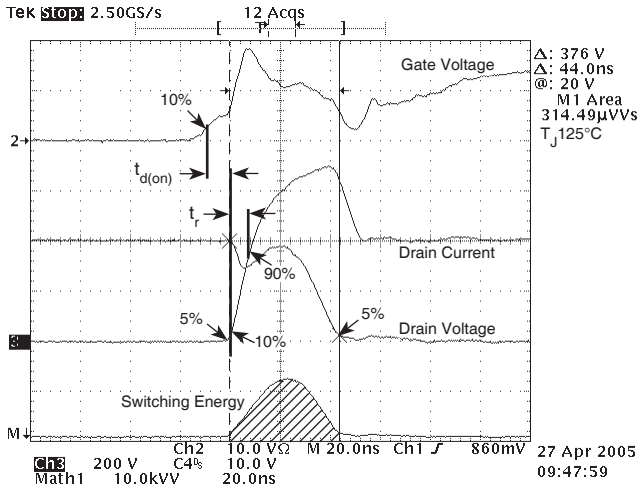

Figure 18, Turn-on Switching Waveforms and Definitions

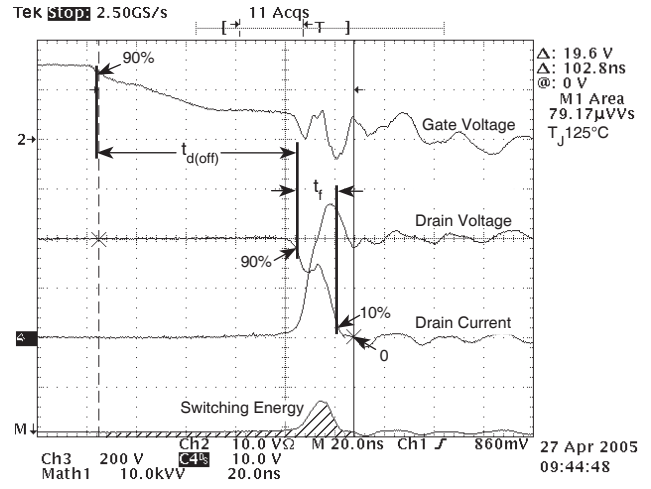

Figure 19, Turn-off Switching Waveforms and Definitions

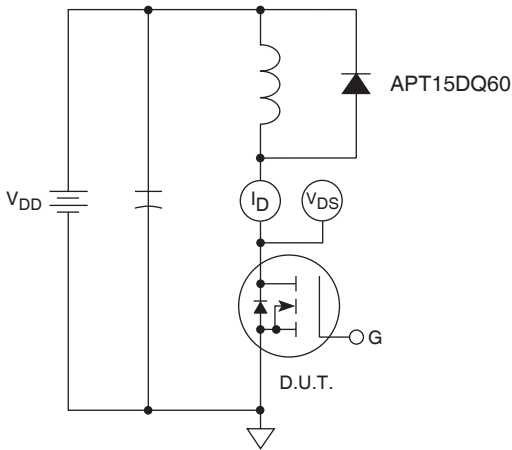
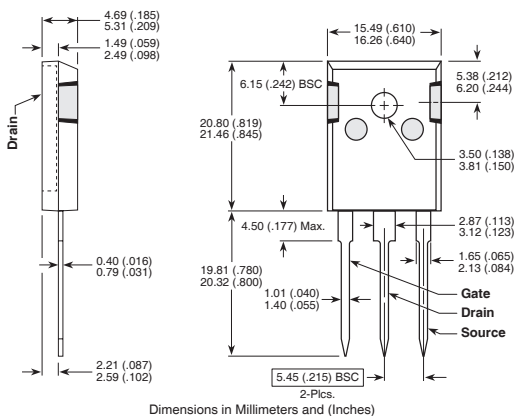

Figure 20, Inductive Switching Test Circuit

TO-247 Package Outline

e1 SAC: Tin, Silver, Copper



Dimensions in Millimeters and (Inches)

APT's products are covered by one or more of U.S. patents 4,895,810 5,045,903 5,089,434 5,182,234 5,019,522

5,262,336 6,503,786 5,256,583 4,748,103 5,283,202 5,231,474 5,434,095 5,528,058 and foreign patents. US and Foreign patents pending. All Rights Reserved.

D³PAK Package Outline

e3 100% Sn

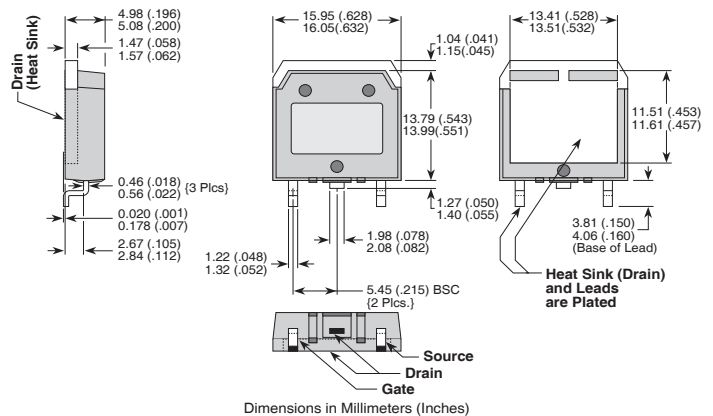

Dimensions in Millimeters (Inches)